

DS-2DE4825IWG1-E**8 MP 25X Powered by DarkFighter IR Acusense Network Speed Dome**

Hikvision DS-2DE4825IWG1-E 8MP 25× Network IR Speed Dome adopts 1/2.8" progressive scan CMOS chip. With the 25× optical zoom lens, the camera offers more details over expansive areas.

This series of cameras can be widely used for wide ranges of high-definition, such as the rivers, roads, railways, airports, squares, parks, scenic spots, and venues, etc.

Empowered by deep learning algorithms, Hikvision AcuSense technology brings human and vehicle targets classification alarms to front- and back-end devices. The system focuses on human and vehicle targets, vastly improving alarm efficiency and effectiveness.

- HIK AI-ISP for excellent noise reduction effect
- High focus speed with self-learning focus technology keep the picture clear every single second
- High quality imaging with 8 MP resolution
- 1/2.8" progressive scan CMOS
- 25× optical zoom and 16× digital zoom provide close up views over expansive areas
- Focuses on human and vehicle targets classification based on deep learning
- Support face capture. Up to 5 faces captured at the same time
- Support link to hikvision network speakers and network microphones to play audio
- Improve playback efficiency and be compatible with the AcuSeek and AcuSearch technologies of NVR for combined use
- Expansive night view with up to 100 m IR distance
- Active strobe light and audio alarm to warn intruders off
- Built-in arrayed dual-microphone for real-time high quality audio security

▪ Specification

Camera	
Image Sensor	1/2.8" progressive scan CMOS
Max. Resolution	3840 × 2160
Min. Illumination	Color: 0.005 Lux @ (F1.6, AGC ON); B/W: 0.001 Lux @ (F1.6, AGC ON), 0 Lux with IR
Shutter Speed	1 s to 1/30,000 s
Day & Night	IR cut filter
Zoom	25x optical, 16x digital
Slow Shutter	Yes
Lens	
Focal Length	4.8 to 120 mm
FOV	Horizontal field of view: 55.3° to 3.0°, vertical field of view: 32.2° to 1.7°, diagonal field of view: 62.3° to 3.4°
Focus	Auto, semi-auto, manual
Aperture	Max. F1.6
Zoom Speed	Approx. 3.6 s
Illuminator	
Supplement Light Type	IR
Supplement Light Range	IR Distance: up to 100 m
PTZ	
Movement Range (Pan)	360°
Movement Range (Tilt)	-15° to 90° (auto flip)
Pan Speed	pan speed: configurable from 0.1° to 80°/s; preset speed: 80°/s
Tilt Speed	tilt speed: configurable from 0.1° to 80°/s, preset speed 80°/s
Proportional Pan	Yes
Presets	300
Preset Freezing	Yes
Patrol Scan	8 patrols, up to 32 presets for each patrol
Pattern Scan	4 pattern scans
Park Action	Preset, pattern scan, patrol scan, auto scan, tilt scan, random scan, frame scan, panorama scan
3D Positioning	Yes
PTZ Status Display	Yes
Scheduled Task	Preset, pattern scan, patrol scan, auto scan, tilt scan, random scan, frame scan, panorama scan, dome reboot, dome adjust, auxiliary output
Power-off Memory	Yes
Video	
Main Stream	50 Hz: 25 fps (3840 × 2160, 2560 × 1440, 1920 × 1080, 1280 × 960, 1280 × 720), 60 Hz: 30 fps (3840 × 2160, 2560 × 1440, 1920 × 1080, 1280 × 960, 1280 × 720)
Sub-Stream	50 Hz: 25 fps (704 × 576, 640 × 480, 352 × 288) 60 Hz: 30 fps (704 × 480, 640 × 480, 352 × 240)
Third Stream	50 Hz: 25 fps (1920 × 1080, 1280 × 960, 1280 × 720, 704 × 576, 640 × 480, 352 × 288) 60 Hz: 30 fps (1920 × 1080, 1280 × 960, 1280 × 720, 704 × 480, 640 × 480, 352 × 240)
Video Compression	Main stream: H.265+/H.265/H.264+/H.264 Sub-stream: H.265/H.264/MJPEG Third stream: H.265/H.264/MJPEG

Video Bit Rate	32 kbps to 16384 kbps
H.264 Type	Baseline Profile/Main Profile/High Profile
H.265 Type	Main profile
Scalable Video Coding (SVC)	H.264 and H.265 encoding
Region of Interest (ROI)	8 fixed regions for each stream
AI Encoding	-(B): Yes
Audio	
Audio Compression	G.711,G.722.1,G.726,MP2L2,PCM,MP3,AAC-LC
Audio Bit Rate	64 Kbps (G.711),16 Kbps (G.722.1),16 Kbps (G.726),32 to 192 Kbps (MP2L2),16 to 64Kbps (AAC-LC),8 to 320 Kbps (MP3)
Audio Sampling Rate	MP2L2: 16kHz, 32kHz, 48kHz,AAC-LC: 16kHz, 32kHz, 48kHz,PCM: 16kHz, 32kHz, 48kHz,MP3: 8kHz, 16kHz, 32kHz, 48kHz
Environment Noise Filtering	Yes
Network	
Protocols	IPv4/IPv6, HTTP, HTTPS, 802.1x, QoS, FTP, SMTP, UPnP, SNMP, DNS, DDNS, NTP, RTSP, RTCP, RTP, TCP/IP, UDP, IGMP, ICMP, DHCP, PPPoE, Bonjour
Simultaneous Live View	Up to 20 channels
API	ONVIF (Profile S, Profile G, Profile T),ISAPI,SDK,ISUP
User/Host	Up to 32 users, 3 user levels: administrator, operator, and user
Security	Password protection, complicated password, HTTPS encryption, 802.1X authentication (EAP-TLS, EAP-LEAP, EAP-MD5), watermark, IP address filter, basic and digest authentication for HTTP/HTTPS, RTP/RTSP over HTTPS, control timeout settings, security audit log, TLS 1.2, TLS 1.3, host authentication (MAC address)
Network Storage	NAS (NFS, SMB/CIFS), auto network replenishment (ANR)
Client	iVMS-4200, HikCentral Pro, Hik-Connect
Web Browser	IE11, Chrome 80+, Firefox 80+, Safari 13+, Edge 89+
Image	
Image Parameters Switch	Yes
Image Settings	Saturation, brightness, contrast, sharpness, gain, and white balance adjustable by client software or web browser
Day/Night Switch	Day, Night, Auto, Schedule
Wide Dynamic Range (WDR)	120 dB
SNR	> 52 dB
Defog	Digital defog
Image Stabilization	EIS
Image Enhancement	BLC, HLC, 3D DNR
Privacy Mask	24 programmable polygon privacy masks, mask color or mosaic configurable
Regional Focus	Yes
Regional Exposure	Yes
VR View	360° Real Scene Stitched Panoramic Image
Interface	
Ethernet Interface	1 RJ45 10M/100M self-adaptive Ethernet port
On-board Storage	Built-in memory card slot, support microSD/microSDHC/microSDXC card, up to 512 GB
Audio	1 input (line in), max. input amplitude: 2-2.4 vpp, input impedance: 1 kΩ ± 10%; 1 output (line out), line level, output impedance: 600 Ω
Alarm	1 input, 1 output

Reset	Yes
Built-in Microphone	2 built-in Microphone: Arrayed dual-microphone up to 8 meters
Built-in Speaker	1 built-in speaker, with effective distance reaching max. 20 meters
Event	
Basic Event	Motion detection, video tampering alarm, exception, alarm input and output
Smart Event	Line crossing detection, intrusion detection, region entrance detection, region exiting detection, unattended baggage detection, object removal detection, audio exception detection
Linkage	Upload to FTP/NAS/memory card, notify surveillance center, send email, trigger alarm output, trigger recording, audible warning, white light flashing, and PTZ actions (such as preset, patrol scan, pattern scan)
Deep Learning Function	
Face Capture	Detects up to 5 faces simultaneously. Supports detecting, capturing, grading, selecting of face in motion, and output the best face picture of the face
Regional People Counting	Supports up to 8 detection regions, and independent arming schedule and linkage method Supports 3 detection modes: people density detection, number of people exception detection, waiting time exception detection Supports searching real-time number of people
General	
Power	12 VDC, max. 18 W, including max. 1.6 W for heater and 9 W for IR; PoE (802.3at)
Dimension	∅ 164.5 mm × 290 mm (∅ 6.48" × 11.42")
Weight	Approx. 2 kg (4.41 lb.)
Material	ADC12
Operating Condition	-30 °C to 65 °C (-22 °F to 149 °F). Humidity 90% or less (non-condensing)
Demist	Yes
Approval	
EMC	CE-EMC (EN 55032:2015+A1:2020, EN 50130-4:2011+A1:2014, EN IEC 61000-3-2:2019+A1:2021+A2:2024, EN 61000-3-3:2013+A1:2019+A2:2021), RCM (AS/NZS CISPR 32: 2015)
Safety	CB (IEC 62368-1:2014), CE-LVD (EN 62368-1:2014 + A11:2017)
Environment	CE-RoHS (2011/65/EU); WEEE (2012/19/EU); Reach (Regulation (EC) No 1907/2006)
Protection	IP67 (IEC 60529-2013), TVS 6000 V lightning protection, surge protection and voltage transient protection

▪ DORI

The DORI (detect, observe, recognize, identify) distance gives the general idea of the camera ability to distinguish persons or objects within its field of view.

It is calculated based on the camera sensor specification and the criteria given by EN 62676-4: 2015.

DORI	Detect	Observe	Recognize	Identify
Definition	25 px/m	63 px/m	125 px/m	250 px/m
Distance (Tele)	3200.0 m (10498.7 ft)	1269.8 m (4166.1 ft)	640.0 m (2099.7 ft)	320.0 m (1049.9 ft)
Distance (Wide)	128.0 m (419.9 ft)	50.8 m (166.6 ft)	25.6 m (84.0 ft)	12.8 m (42.0 ft)

▪ Dimension

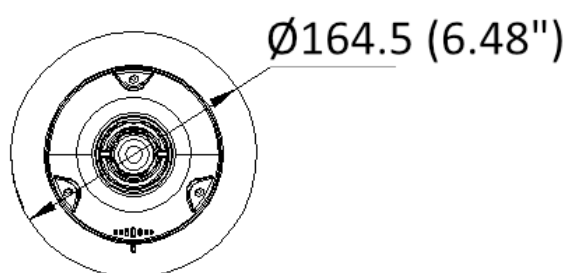
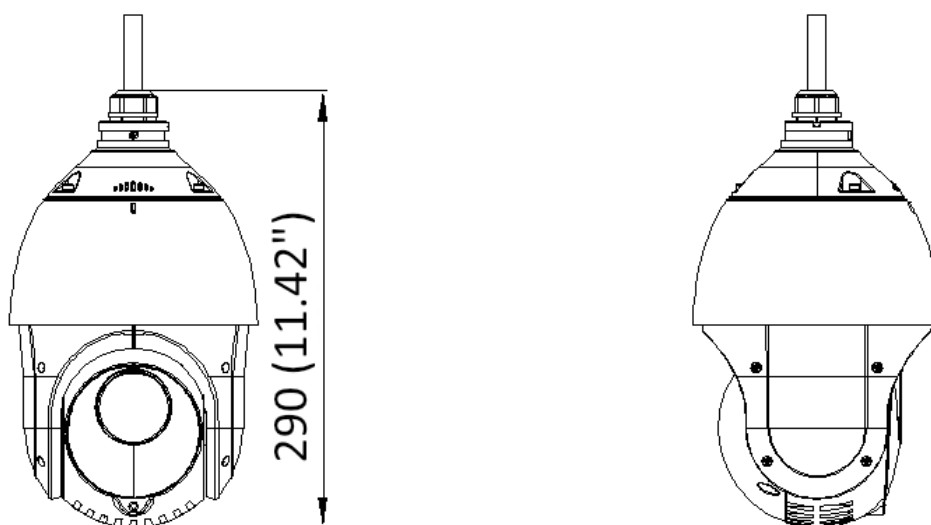









Unit: mm (inch)

▪ **Accessory**

▪ **Included**







▪ **Optional**

DS-1661ZJ	DS-1673ZJ	DS-1604ZJ-pole	DS-1662ZJ	DS-1619ZJ
				
DS-1604ZJ-BOX-PO LE	DS-1663ZJ	DS-1661ZJ-R/B	DS-1602ZJ-R/B	DS-1604ZJ-BOX-CO RNER
				
DS-1684ZJ	DS-1604ZJ-box			
				

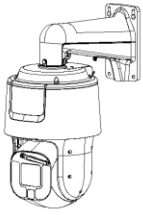
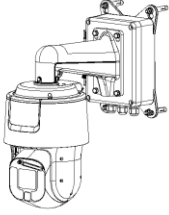
▪ **Installation Methods**

Wall Mounting DS-1618ZJ	Wall Mounting DS-1604ZJ-box	Pendant Mounting DS-1661ZJ	Pendant Mounting DS-1662ZJ	Pendant Mounting DS-1663ZJ
----------------------------	--------------------------------	-------------------------------	-------------------------------	-------------------------------

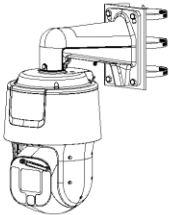
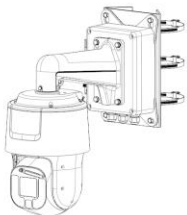
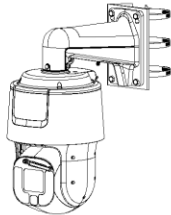
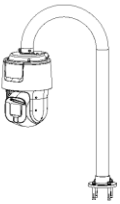
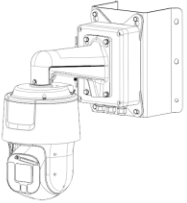
				
<p>Horizontal Pole Mounting DS-1673ZJ+DS-1662ZJ</p>	<p>Vertical Pole Mounting DS-1604ZJ-pole</p>	<p>Vertical Pole Mounting DS-1604ZJ-BOX-POLE</p>	<p>Vertical Pole Mounting DS-1684ZJ+DS-1602ZJ</p>	<p>Gooseneck Mounting DS-1619ZJ</p>
				
<p>Corner Mounting DS-1604ZJ-BOX-CORNER ER</p>				
				

See Far, Go Further



www.hikvision.com
support@hikvision.com

